

# POWER ANALYZER *PRO*



<b>SAFETY FIRST .....</b>	<b>4</b>
<b>E-FLIGHT 101 – MEASUREMENTS OF THE PRO.....</b>	<b>5</b>
Basics of Electricity .....	5
Measuring Power with Watts .....	5
Measuring Capacity with Amp-Hours.....	6
Measuring Work with Watt-Hours .....	6
RPM, Volts, Amps, KV, Torque and More.....	6
The Medusa Research Thrust Cell.....	7
<b>SETUP .....</b>	<b>8</b>
Attach Connectors .....	8
Applying Power.....	8
<b>DISPLAY .....</b>	<b>9</b>
Power-up Screen.....	9
Measurments on the Display.....	10
Voltage .....	10
Current .....	10
Analog AUX Port .....	10
Temperature .....	10
Power .....	11
Amp-Hours .....	11
Watt-Hours .....	11
RPM .....	11
Thrust.....	11

<b>Display Configuration.....</b>	<b>12</b>
<b>EXTERNAL SENSORS.....</b>	<b>13</b>
<b>RPM Sensor.....</b>	<b>13</b>
<b>Temperature Probe .....</b>	<b>15</b>
<b>AUX Port .....</b>	<b>16</b>
<b>AUX Port as an Analog Input .....</b>	<b>16</b>
<b>AUX Port as a Thrust Cell Input .....</b>	<b>17</b>
<b>ESC PORT.....</b>	<b>18</b>
<b>USB PORT.....</b>	<b>18</b>
<b>USING THE POWER ANALYZER .....</b>	<b>19</b>
<b>Measuring the Capacity of a Battery .....</b>	<b>19</b>
<b>Measuring Charge put into a Battery .....</b>	<b>20</b>
<b>Measuring Motor Load.....</b>	<b>20</b>
<b>SPECIFICATIONS.....</b>	<b>21</b>
<b>APPENDIX A—BATTERY CELL VOLTAGES .....</b>	<b>23</b>
<b>SUPPORT .....</b>	<b>24</b>
<b>WARRANTY.....</b>	<b>24</b>
<b>Limited Warranty.....</b>	<b>24</b>
<b>Limits and Exclusions .....</b>	<b>24</b>
<b>Limitation of Liability .....</b>	<b>25</b>
<b>RETURNS AND RETURN AUTHORIZATION .....</b>	<b>26</b>

## SAFETY FIRST

### CAUTION CURRENT HANDLING LIMITATIONS

The Power Analyzer PRO is designed and built for safe use in systems carrying currents up to 100 Amps. Exceeding 100 Amps could result in damage to the equipment and possible personal injury.

### CAUTION INPUT VOLTAGE LIMITATIONS

The Power Analyzer PRO is designed and built for safe use in systems with less than 60 Volts. Exceeding 60V can permanently damage the Power Analyzer PRO.

### CAUTION HARDWARE AND CONNECTIONS

Follow proper assembly and ratings for wires and connectors. The user is responsible for attaching connectors rated to handle the voltage and current that will be applied in the user's application. Ensure that all wiring and connections are rated to handle the input or output current, and are assembled appropriately for each application. High current connections should be made by those experienced to do so.

### CAUTION APPLYING POWER

Before connecting a battery to the Power Analyzer PRO, make certain there are no exposed wires or connectors that may short circuit. Connectors with exposed male conductors should never be used on batteries, use female connectors for batteries. Both the "SOURCE" and "LOAD" leads of the Power Analyzer PRO are hot when a battery is connected to either side. A shorted Power Analyzer connected to a battery can supply massive amounts of current, causing fire, explosions, personal injury, and damage to the equipment.

## E-FLIGHT 101 – MEASUREMENTS OF THE PRO

### ***BASICS OF ELECTRICITY***

Our Power Analyzer PRO can measure all of the necessary electric properties of your setup that you will need to know to get the most out of your model. In addition, it can also measure other properties including **RPM, thrust, and temperature**. This provides the user with a complete data acquisition system that not only has electric measurements, but all the important dimensions of your e-flight system. What follows in this section is a basic description of the electric measurements.

Electricity in a wire is often compared to water flowing through a hose. Like water flowing through a hose, current is a measure how *fast* electricity flows through a wire. To get the water to *flow* through the hose, there needs to be a relatively high *pressure* at the faucet end of the hose to push the water out the open end where there is relatively little pressure. It is this difference in *pressure* that creates the *flow* in the hose. For electronics, this difference in pressure is known in electronics as voltage. The battery pack is analogous to the garden faucet, because it creates the voltage to make current flow through a wire and into your motor where it is converted from electricity into mechanical rotation.

### ***MEASURING POWER WITH WATTS***

The combination of the pressure of electric voltage and the flow of current is what produces a flow of power. Power in electronics is usually measured in watts. The Power Analyzer PRO will display the amount of power flowing through it in watts. Wattage can also be calculated by multiplying the current by the voltage.

$$\text{Watts} = \text{Amps} \times \text{Volts}$$

The power flowing into the motor can be compared to the power flowing out of the motor and into the propeller. The difference between the power going into the motor and power going out is known as *efficiency*. The goal of the modeler is to optimize the setup to get the highest efficiency possible. The Power Analyzer PRO can measure electric power in with watts, and power out using the Thrust Cell and RPM sensor.

## **MEASURING CAPACITY WITH AMP-HOURS**

The Amp-Hour is a standard measure of capacity for electric battery packs. This measurement is useful when charging battery packs to determine if they are taking a full charge, if they should be re-conditioned, or if they should be recycled and replaced. The Amp-Hour specification for a battery is usually printed on the pack.

$$\text{Amp-Hours} = \text{Average Amps} \times \text{Hours}$$

Thinking back to the water example, a discharged battery is like an empty bucket. The faucet is like a bucket charger that creates pressure and flow to fill the bucket back up with water. For example, if the bucket is 2 gallons, and the faucet fills the bucket at 2 gallons an hour it will take one hour to fill the bucket. When a discharged 2 Amp-Hour (usually printed as 2000mAh for milliamp hours) battery pack is charged at 2 Amps for 1 Hour the battery will be fully charged, just like the bucket is full of water.

## **MEASURING WORK WITH WATT-HOURS**

Similar to Amp-Hours, Watt-Hours measures power multiplied by time to determine how much "work" capacity is in a battery. The difference is that Watt-Hours incorporate the average voltage as well as the average amperage. Watt-Hours are calculated by:

$$\text{Watt-Hours} = \text{Average Watts} \times \text{Hours}$$

While Amp-Hours are the standard for measuring battery capacity, Watt-Hours can be useful for comparing power capacities between batteries with different number of cells and therefore different voltages. Measuring watt-hours allows you to see and compare the power capacity of your batteries.

## **RPM, VOLTS, AMPS, KV, TORQUE AND MORE...**

A motor's RPM or speed is directly related to the voltage applied to it and the KV of the motor. The KV of a motor is how many RPMs per Volt and it is usually found printed on the motor or in the motor's instructions. For example, a 2000Kv motor with a 12v battery pack should run about  $2000\text{KV} \times 12\text{V} = 24,000\text{RPM}$  unloaded.

If a propeller is attached to the motor, the motor must put power into turning the propeller to generate thrust. The battery's voltage remains constant, so to put power into the propeller, the motor must draw more current. (remember,  $\text{Watts} = \text{Volts} \times \text{Amps}$ ). Just like voltage is related to RPM, *torque* is directly related to the current going into the motor. In a perfect world the motor would

maintain its RPM under any load. In the real world increasing current will increase power losses in the battery, wiring, ESC and motor causing a drop in RPM.

Using the Power Analyzer PRO RPM sensor is a key piece to measuring the approximate efficiency of the electric flight system. This information can provide an approximate measure of the motor's power output that can be compared to the motor's power input.

### ***THE MEDUSA RESEARCH THRUST CELL***

Thrust is important in assessing the performance of an airplane. Knowing the RPM and thrust provide crucial insight into how the model airplane will behave while flying. The Thrust Cell provides an easy method to automate analyzing and recording the thrust produced by different setups so the user can quickly determine the best setup.

## SETUP

### STOP! READ THE FOLLOWING

Due to the wide variety of applications the Power Analyzer PRO may be used in, the Power Analyzer PRO is supplied without connectors. Please read the SAFETY FIRST section before continuing.

### ATTACH CONNECTORS

Before using the Power Analyzer PRO, connectors need to be installed on the SOURCE and LOAD leads. When installing gender specific connectors, the male type should be installed on the SOURCE side and the female type should be installed on the LOAD side. Ensure the connectors are rated to carry the amount of current that the Power Analyzer PRO will be used to monitor. **PAY ATTENTION TO POLARITY!**



Carefully insulate the connector with shrink tube or electrical tape. Make sure the positive and negative leads on both sides are insulated from each other, or a dangerous short circuit may occur.

### APPLYING POWER

The Power Analyzer PRO can be powered 3 different ways.

- Through the USB port.
- By the battery connected to the SOURCE side
- Through the PWR/EXT port on the SOURCE side of the case

The battery connected to the SOURCE side should have at least 6 volts to properly power the Power Analyzer PRO. A NiCd or NiMH pack will need at least 5 cells to do this, a Lithium pack will need 2 cells.

If the battery connected to the SOURCE side has fewer cells or the measured voltage is lower than 6 volts, connect an external power supply to the EXT/PWR port. The EXT/PWR port is designed to accommodate the connector from a standard flight pack, a nickel cell flight pack will need at least 5 cells to power the Power Analyzer PRO.

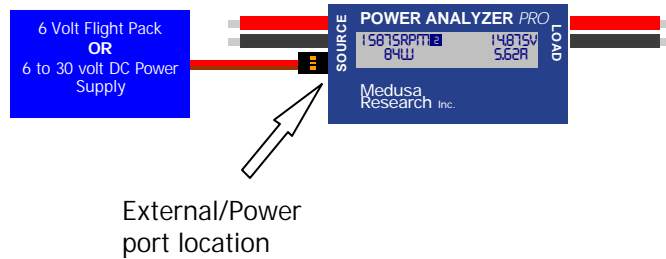

## DISPLAY

### POWER-UP SCREEN

Upon applying power the Power Analyzer PRO will boot up, briefly showing our logo, then the PRO version. Optionally, the PowerPROview software can add a customized 16-letter string above the version to personalize your PRO.

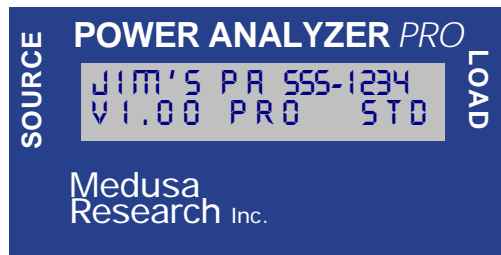

## MEASUREMENTS ON THE DISPLAY

The Power Analyzer PRO is able to display 10 separate measurements but because of limited space on the display, only 4 measurements are shown simultaneously. The PRO can change the measurements shown on the display at a user-defined interval; see the Screen Configuration section for more details. Each measurement may occupy 1 position on each screen. The 10 different measurements are:

- *Voltage*                    **0 to 60 Volts**
- *Current*                    **-30 to 100 Amps**
- *Aux port*                    **0.1 to 2.6V analog input**
- *Temperature 1*            **0°C to 130°C**
- *Temperature 2*            **0°C to 130°C**
- *Power*                      **-1800 to 6000 watts**
- *Amp-Hours*                **+/- 999.999**
- *Watt-Hours*               **+/- 9999.9**
- *RPM*                        **60,000 for 2 to 7 blades**
- *Thrust*                      **0 to 5000g**

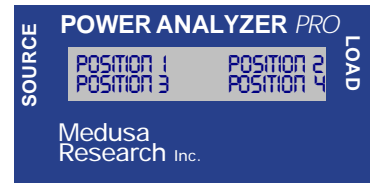

## VOLTAGE

Voltage indicates the voltage present at the SOURCE leads and has a range of 0 to 60 volts.

## CURRENT

Current indicates the current flowing through the negative lead of the Power Analyzer PRO. It can read up to 100 amps in the forward direction, and up to -30 amps in the reverse direction from LOAD to SOURCE.

## ANALOG AUX PORT

The Aux port, if it is not used for the Thrust Cell, can be configured as a generic analog input with a linear input range of 0.1V to 2.6V. Using PowerPROview software, the user can configure gain and offset factors to apply to the reading shown on the display. **THE MAXIMUM INPUT RANGE IS -0.1V to 5.0V. VOLTAGE OUTSIDE OF THE MAXIMUM RANGE WILL CAUSE ERRONEOUS READINGS ON OTHER CHANNELS AND POSSIBLE DAMAGE TO THE POWER ANALYZER PRO!**

## TEMPERATURE

Temperature on both channels can be displayed in Centigrade or Fahrenheit with a range of 0 to 130 °C or 32 to 266 °F. On the display, a reverse color 1 or 2

character will appear after the temperature to indicate if it is channel 1 or channel 2. The PowerPROview software is necessary to configure the temperature scale.

### **POWER**

Power is shown in watts and indicates the power as positive when flowing from the SOURCE to the LOAD and negative to indicate the power is flowing from the LOAD to the SOURCE. The range for power is –1800 to 6000 watts

### **AMP-HOURS**

Amp-hours indicates the amount of current times time that has flowed through the Power Analyzer PRO. The Amp-Hours indication will count up for positive current flow, and down for negative current flow.

### **WATT-HOURS**

Amp-hours indicates the amount of power times time that has flowed through the Power Analyzer PRO. The Watt-Hours indication will count up for positive current flow, and down for negative current flow.

### **RPM**

The RPM reading can display 0 to 60,000 RPM for propellers and fans with 2 to 7 blades. The user can also configure the RPM resolution to 100, 50, and 25 RPM resolution with the tradeoff being that higher resolution requires a slower sample rate. RPM settings can only be configured though the USB port with the appropriate PC software. See the table below for the sample rates of each configuration.

<b>RPM Sample rates in seconds, by Resolution and Blade count</b>			
<b>Blades/Resolution</b>	<b>100 RPM Res.</b>	<b>50 RPM Res.</b>	<b>25 RPM Res.</b>
<b>2 Blades</b>	0.30s	0.60s	1.20s
<b>3 Blades</b>	0.20s	0.40s	0.80s
<b>4 Blades</b>	0.21s	0.30s	0.60s
<b>5 Blades</b>	0.21s	0.24s	0.48s
<b>6 Blades</b>	0.21s	0.21s	0.40s
<b>7 Blades</b>	0.21s	0.21s	0.34s

### **THRUST**

The *Thrust* value is selectable between grams and ounces and has a range of 0 to 5000kg or 0 to 176oz (11lbs). The PowerPROview software is necessary to configure the PRO for grams or ounces mode.

## DISPLAY CONFIGURATION

To overcome the limited screen size, the PRO can have up to 5 different screen layouts that will rotate at a user defined speed. The PRO ships from the factory with 3 screens that switch every 2 seconds. The layout for each configuration is shown in the table below.

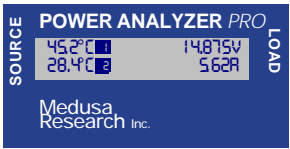
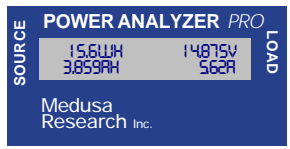
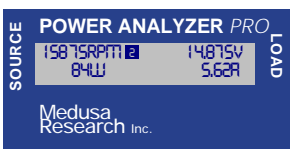
Factory Default Screen Configuration		
Screen 1		<ul style="list-style-type: none"> <li>• Position 1 Temperature 1</li> <li>• Position 2 Voltage</li> <li>• Position 3 Temperature 2</li> <li>• Position 4 Current (amps)</li> </ul>
Screen 2		<ul style="list-style-type: none"> <li>• Position 1 Watt-Hours</li> <li>• Position 2 Voltage</li> <li>• Position 3 Amp-Hours</li> <li>• Position 4 Current (amps)</li> </ul>
Screen 3		<ul style="list-style-type: none"> <li>• Position 1 RPM (2 blades)</li> <li>• Position 2 Voltage</li> <li>• Position 3 Power (watts)</li> <li>• Position 4 Current (amps)</li> </ul>

Using our PowerPROview software, the layouts of the screens can be arranged in any configuration. As shown by the voltage and current display in the default configuration above, it is possible to have the same measurements on 2 or more screens so important data will always be visible. It is also important to note that though the PRO ships with only 3 screens enabled, the user may enable up to 5 unique screens. The user can also change the speed at which the screens change.

## EXTERNAL SENSORS

### RPM SENSOR

The RPM sensor accessory is an advanced reflective type of sensor. Instead of relying on ambient light or a flashlight, the sensor has both an infrared emitter to bounce light off of the propeller or fan blades and infrared filtered sensor detects the reflected light. This allows the sensor to be used under normal room lighting without the kind of interference from fluorescent light sources that plague other tachometers. The threaded holes on the sensor use 4-40 thread screws.

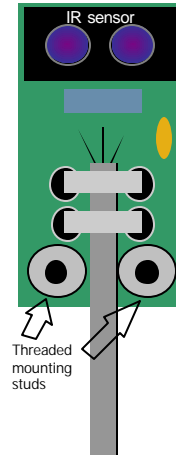

The RPM sensor should be mounted to a test stand no more than 7/8" away from the propeller of the system under test. Some experimentation may be necessary to determine the best distance and position before permanently mounting the sensor. The sensor can be affected by the color of the propeller or fan because it is a reflective type sensor. If there is a poor reading from the RPM sensor and the target propeller is a dark color, we recommend either painting white stripes on the target area, or backlighting the sensor as described below.

On a narrow propeller target, the sensor can also be sensitive to how it is oriented in relation to the propeller. For best results, when the prop blade crosses the path of the IR sensor (shown below) it should cross the path of both the emitter and receiver at the same time. The sensor should also be mounted at the same angle as the propeller blade, otherwise the IR light beam will not return to the sensor as effectively.

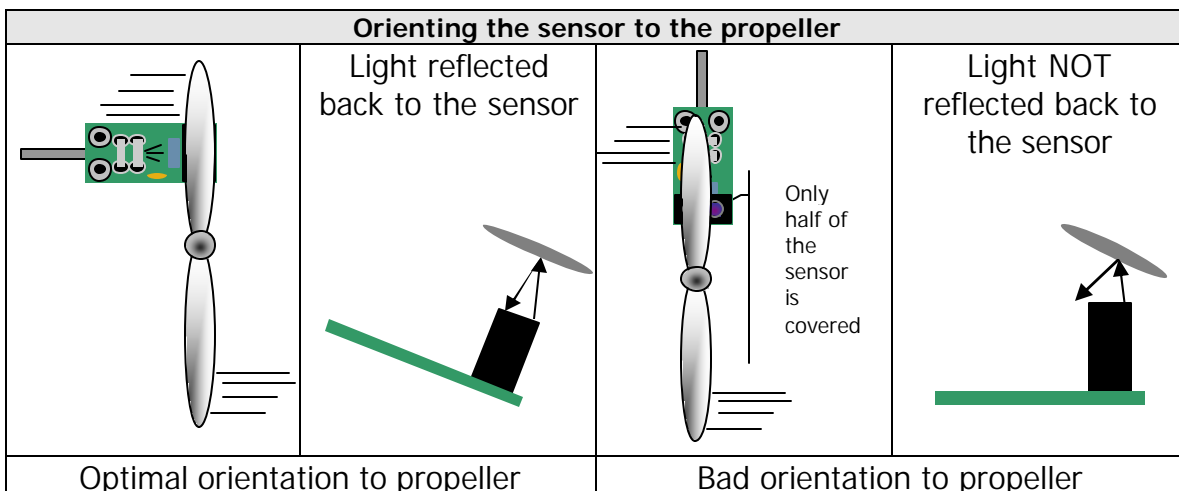

**DO NOT ATTEMPT TO HOLD THE SENSOR BY HAND WHILE TESTING!** Instead, use the mounting studs to securely mount the sensor to your test stand.

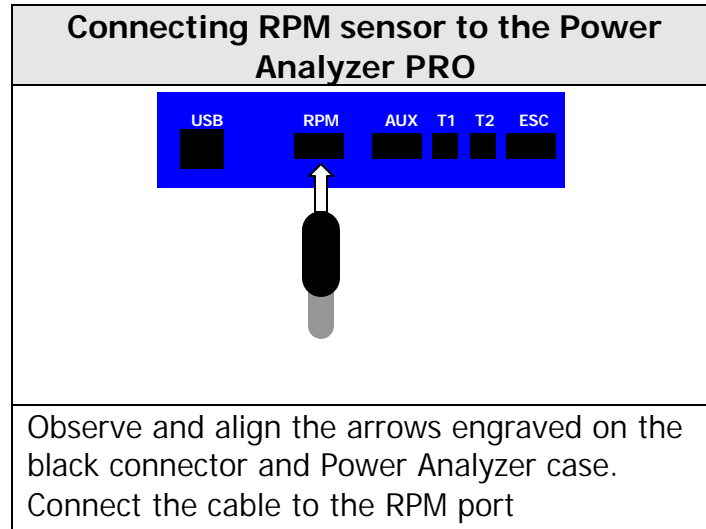

If the sensor's operating range is too short, the range can be dramatically extended to 12" and beyond by backlighting the sensor with a DC incandescent light source such as a flashlight. Incandescent bulbs emit a broad range of light that will penetrate the infrared filter if the beam is directly focused on the sensor. The sensor can also pick up false signal from room lights ONLY if they are focused on the sensor. If you notice false readings, try re-orienting the lighting, sensor, or both.

## **TEMPERATURE PROBE**

The temperature probe accessory allows the user to monitor temperature of vital parts during testing. A ring type mounting is provided on the sensor end for bolting to motors or other surfaces. Alternatively, it is also possible to secure the sensor with tape for measuring ESCs, batteries or other devices. For best results, the sensor should be shielded from heavy airflow (such as from the propeller wash) and a thermal grease compound will improve sensor accuracy.

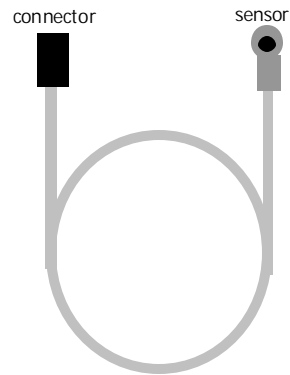

**Connecting temperature probe sensor to the Power Analyzer PRO**

A diagram of the Power Analyzer PRO case with a blue top section. The top section has several ports labeled: USB, RPM, AUX, T1, T2, and ESC. Two black sensors with white arrows pointing upwards are shown connected to the T1 and T2 ports.

Observe and align the arrows engraved on the black connector and Power Analyzer PRO case. Connect 1 or 2 sensors to the T1 and/or T2 locations in the Power Analyzer PRO.

## **AUX PORT**

The Aux port can be used in two modes. It will either function as a generic analog input for a user-defined sensor, or as a communications port for the Medusa Research Thrust Cell. The Power Analyzer is shipped from the factory in Thrust Cell mode

### **AUX PORT AS AN ANALOG INPUT**

If the AUX port is not used for the Thrust Cell, it can be configured as a generic analog input with a linear input range of 0.1V to 2.6V. Using PowerPROview software, the user can configure gain and offset factors to apply to the reading shown on the display. **THE MAXIMUM INPUT RANGE IS -0.1V to 5.0V. VOLTAGE OUTSIDE OF THE MAXIMUM RANGE WILL CAUSE ERRONEOUS READINGS ON OTHER CHANNELS AND POSSIBLE DAMAGE TO THE POWER ANALYZER PRO!**

The port will accept a standard 3-pin female inline connector with 0.100" pin spacing. A standard 3 wire servo cable will fit into the port as well. The pinout, from left to right is:

Pin 1: **Signal** (engraved arrow); Pin 2: **No Connect** Pin 3: **Ground**

**PIN 2 MUST BE LEFT UNCONNECTED, DO NOT CONNECT THIS PIN TO GROUND!**

## AUX PORT AS A THRUST CELL INPUT

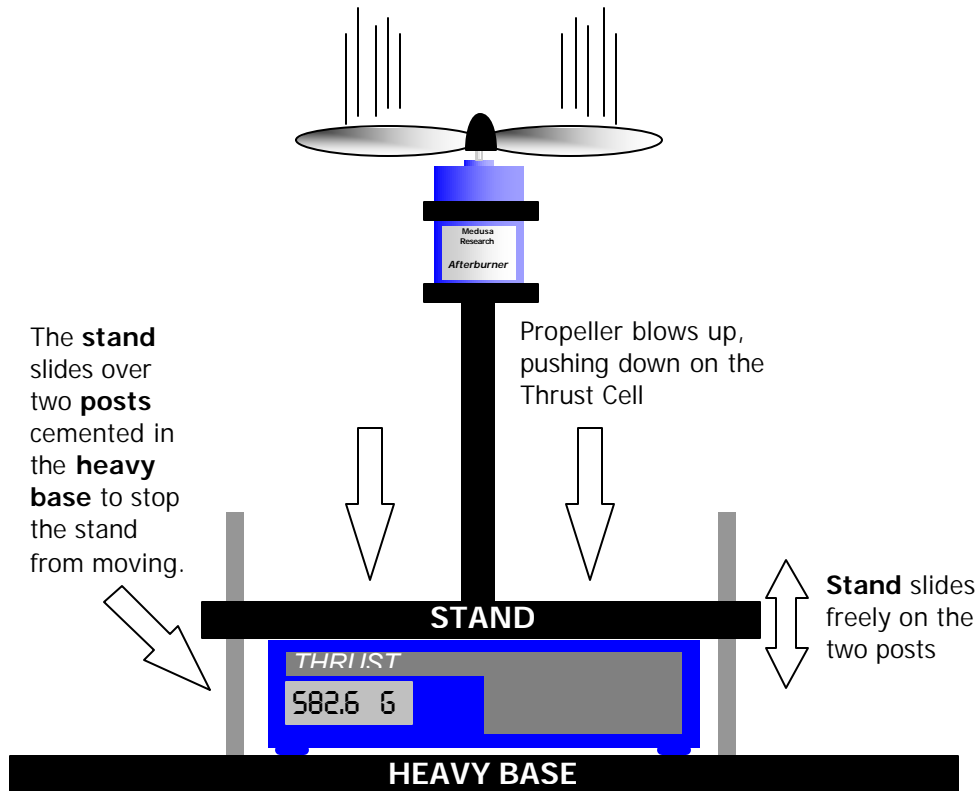

The Thrust Cell is used to measure thrust using a fixture like the one shown in the picture below. The Thrust Cell was designed in the format of a common tabletop scale because that is what many hobbyists currently use to measure thrust. For accuracy, the stand should be tall enough that the moving air does not generate a significant pressure difference between the top and bottom of the stand. **The user is responsible for all measures necessary to conduct tests safely!** Medusa Research *strongly* recommends that the above fixture be enclosed in a wire mesh or "chicken wire" cage to contain the fixture should parts come loose while testing.

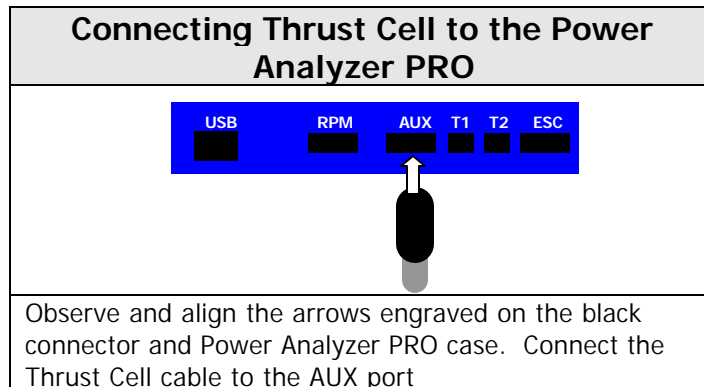

## ESC PORT

The Power Analyzer PRO can control your ESC for automated testing with the ESC port. In combination with the PowerPROview software, the user can manually control the ESC through the PC, or even create custom throttle profiles to make perfectly repeatable tests for comparing different setups.

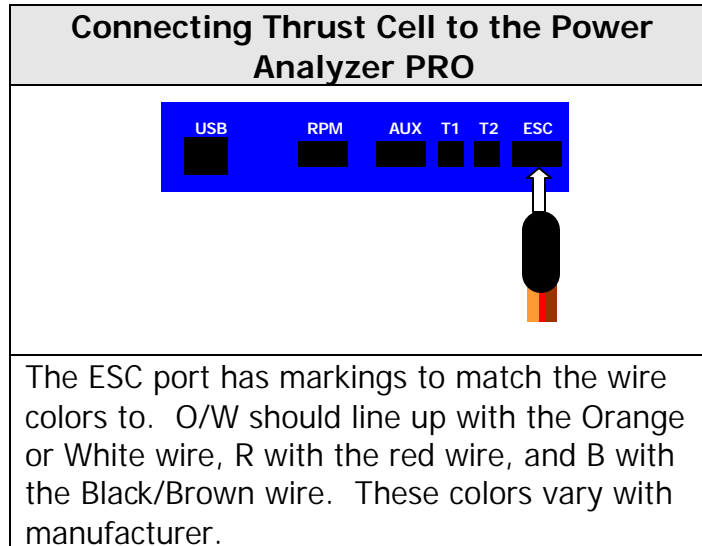

## USB PORT

Minimum System Requirements

400mHz Pentium II or equivalent, 128mb RAM, 50 mb free disc space

800x600 minimum graphics resolution, USB v1.1 compatible port

Operating systems supported: 98SE, 2000, or XP

**BEFORE CONNECTING THE POWER ANALYZER PRO TO YOUR COMPUTER:**

Download and install the latest Power Analyzer PRO compatible software from

<http://www.medusaproducts.com>

## USING THE POWER ANALYZER

### *MEASURING THE CAPACITY OF A BATTERY*



The capacity of a battery can be measured by completely discharging a fully charged battery. In order to do this, first connect a load to the LOAD side of the Power Analyzer PRO. A load may be a battery charger with a discharge feature, or an ESC and motor. Second, connect a battery to the SOURCE side of the Power Analyzer PRO. Run the motor or discharge until the battery is at its discharged voltage. When the battery is discharged, the final battery capacity (in Amp Hours) will be displayed.

## MEASURING CHARGE PUT INTO A BATTERY



The Power Analyzer PRO can also be used to monitor the charge being put into a rechargeable battery. In this configuration, the battery charger is putting current into the battery instead of drawing it out like a motor. Therefore, the battery becomes the load and the current flows in reverse, from the LOAD to the SOURCE. It is unnecessary to swap the battery to the LOAD side like some other power meters on the market, the Power Analyzer PRO will read current flow in both directions. The current will show up as negative to indicate the reverse direction. Follow your battery charger's instructions, and charge the battery as you normally would. At the end of the charge cycle, the amount of charge put into the battery will be displayed in amp-hours on the display.

**NOTE:** Always follow the charging procedure recommended by the battery manufacturer to safely charge the battery

## MEASURING MOTOR LOAD

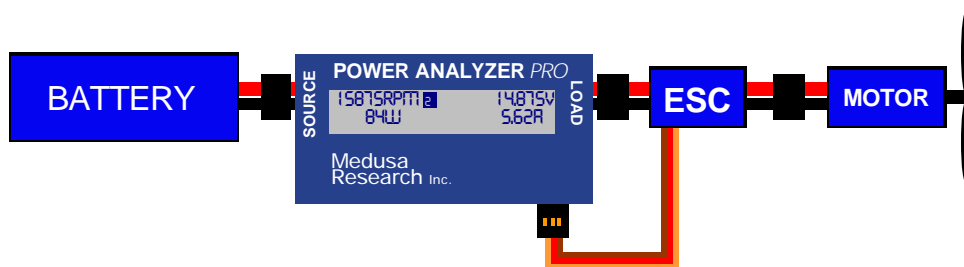

Measuring motor load is critical in finding the optimal propeller size and gearbox ratio.

To control the ESC from your computer and measure motor load, you will need to install PowerPROview to control the ESC port. Connect the ESC to the ESC port of the Power Analyzer PRO. Then connect the LOAD side of the Power Analyzer PRO to an ESC and connect the ESC to a motor. Finally, connect a fully charged battery to the SOURCE lead. This step will energize your ESC, so make sure you follow your ESC's instructions and safety procedures for connecting a battery. It is now possible to control the ESC through the PC with the PowerPROview software.

## SPECIFICATIONS

Technical Specifications		
<b>Input Specifications</b>	Minimum	Maximum
<b>Input Voltage</b>	5 Volts	60 Volts
	0 Volts*	
<b>Current</b>	-30 Amps	100 Amps
Display Range		
<b>Voltage</b>	60 Volts	
<b>Current</b>	-30 to 100 Amps	
<b>Power</b>	9999 Watts	
<b>Amp-Hours</b>	±999.999 AH	
<b>Watt-Hours</b>	±9999.9 WH	
<b>Temperature Channels 1 &amp; 2</b>	0°C to 130°C or 32°F to 266°F (user selectable)	
<b>RPM</b>	60,000 (up to seven blades)	
<b>Thrust</b>	5,000g	
<b>Auxiliary Analog Input**</b>	0.1V - 2.6V, User configurable display value	
Display Resolution		
<b>Voltage</b>	0.005 V	
<b>Current</b>	0.010 A	
<b>Watts</b>	1 W	
<b>Amp-Hours</b>	0.001 AH	
<b>Watt-Hours</b>	0.1 WH	
<b>Temperature Channels 1 &amp; 2</b>	0.1°C or F	
<b>RPM</b>	25, 50, or 100 (user selectable)	
<b>Thrust</b>	0.5g	
<b>Auxiliary Analog Input</b>	160µV	

<b>Accuracy</b>	
<b>Offset</b>	±1 count
<b>Voltage</b>	±0.1% of reading ±1 count
<b>Current</b>	±0.1% of reading ±1 count
<b>Temperature Channels 1 &amp; 2</b>	±1°C or ±1.8°F
<b>RPM</b>	±0.1% of reading ±1 count
<b>Thrust</b>	±0.1% of reading ±1 count
<b>Auxiliary Analog Input</b>	±0.1% of reading ±1 count
<b>Auxiliary Power Connector Requirements</b>	
<b>Voltage</b>	6-30 Volts
<b>Current</b>	30 mA

## APPENDIX A—BATTERY CELL VOLTAGES

NiMH and NiCD cells			
Cells	Discharged Voltage	Normal Voltage	Max Voltage
5	3.75	6.00	6.75
6	4.50	7.20	8.10
7	5.25	8.40	9.45
8	6.00	9.60	10.80
9	6.75	10.80	12.15
10	7.50	12.00	13.50
11	8.25	13.20	14.85
12	9.00	14.40	16.20
13	9.75	15.60	17.55
14	10.50	16.80	18.90
15	11.25	18.00	20.25
16	12.00	19.20	21.60
17	12.75	20.40	22.95
18	13.50	21.60	24.30
19	14.25	22.80	25.65

Lithium Cells			
Cells	Discharged Voltage	Normal Voltage	Max Voltage
1	3.0	3.7	4.3
2	6.0	7.4	8.6
3	9.0	11.1	12.9
4	12.0	14.8	17.2
5	15.0	18.5	21.5
6	18.0	22.2	25.8
7	21.0	25.9	30.1
8	24.0	29.6	34.4
9	27.0	33.3	38.7

NOTE: The “Discharged Voltage” column shows the voltage for a battery pack under load. When discharging a battery through the Power Analyzer PRO, the “Discharged Voltage” is the recommended voltage at which the discharging should be stopped. Consult your battery datasheet for more detailed information.

## **SUPPORT**

If you are still having difficulties, or have questions that aren't covered in this manual, you can contact Medusa Research for support.

Our contact information is:

### **World Wide Web**

<http://www.medusaproducts.com>

### **E-Mail**

[support@medusaproducts.com](mailto:support@medusaproducts.com)

### **Telephone Support**

Hours: Monday-Friday 10am to 5pm eastern time, excluding business holidays

Phone Number: 508.675.0200 (in Fall River, Massachusetts)

## **WARRANTY**

### ***LIMITED WARRANTY***

Medusa Research Incorporated warrants all Power Analyzers PRO to be free of manufacturing defects in material and workmanship for a period of 12 months from the original date of purchase. Should any defects covered by this warranty be found, the Power Analyzer PRO shall be repaired or replaced with a unit of equal performance by Medusa Research Incorporated.

In the event of a product defect during the warranty period, see the directions in the "Returns and Return Authorization" section.

### ***LIMITS AND EXCLUSIONS***

Only the original purchaser, who uses the Power Analyzer PRO in strict accordance with the information provided in this operation guide, may enforce this warranty.

This Warranty does not apply to:

1. Damage resulting from failure to follow instructions provided in this operations guideline
2. Damage resulting from misuse, reverse polarity on input or output wires, abuse or neglect.

3. Damage occurring as a result of poor solder joints, connector incompatibility, or mechanical failure of user installed input and output connections.
4. Damage resulting from any repair or alteration performed by someone other than Medusa Research Inc.

### *LIMITATION OF LIABILITY*

(i) UNDER NO CIRCUMSTANCES WILL MEDUSA RESEARCH, INC. BE LIABLE FOR ANY INDIRECT, THIRD PARTY, SPECIAL, INCIDENTAL, CONSEQUENTIAL OR EXEMPLARY EXPENSES, COSTS, LIABILITY, LOSS, OR DAMAGE WHATSOEVER IN ANY CONNECTION WITH THE USE OR MISUSE OF, OR INABILITY TO USE THIS PRODUCT;

(ii) that Medusa Research, Inc. shall not be liable for any harm, loss, damages, expenses, costs, suit, claim or demand whatsoever against the user of this product;

(iii) that neither Medusa Research, Inc., nor any of its representatives, employees, officers, directors, agents, distributors, affiliated corporations or any other person, shall be responsible for nor shall incur, any liability, damages, loss, obligations or responsibility whatsoever (whether in equity, contract, tort or otherwise) for any harm, loss, reliance, or damages, whatsoever, that may arise in any connection with or result from any promise, advice, arrangement, agreement, statement, technical support or maintenance, representation, warranty, or information whatsoever, that may have been made to by Medusa Research, Inc.;

## **RETURNS AND RETURN AUTHORIZATION**

For warranty and repair returns, please download a *returns form* from our website.

Instructions for packaging and shipping returns are also on our website. If you do not have access to the Internet, please call or fax us at the number below.

Medusa Research Inc.  
288 Plymouth Avenue  
Fall River, Massachusetts  
02721-4226

Phone: 508.675.0200  
Fax: 508.675.0202  
Email: [support@medusaproducts.com](mailto:support@medusaproducts.com)  
Website: [www.medusaproducts.com](http://www.medusaproducts.com)

Copyright ©2005  
Medusa Research, Inc.  
All Rights Reserved

No portion of this document may be reproduced or used in any form  
or by any means- graphic, electronic, or mechanical, including photocopying,  
recording, taping, or information storage and retrieval systems -  
without the written permission of Medusa Research, Inc.

Medusa Research, Inc.  
288 Plymouth Ave.  
Fall River, MA 02721  
Phone: (508)675-0200  
Fax: (508)675-0202  
Email: [info@medusaproducts.com](mailto:info@medusaproducts.com)

Document P/N 821A00014 Rev B